

# Small Generation Interconnection Guidelines

Revision 6.2

Date: 01/15/2025



| <b>Revision Date</b> | <b>Description of Changes</b>   | <b>Revision</b> |
|----------------------|---|-----------------|
| 05/15/2024           | Added sections regarding meter locations and AC Disconnects. Updated one-line diagram examples.                           | 6               |
| 07/23/2024           | Updated to harmonics table (section 9B) to remove a typo. Updated table containing procedure number and name of document. | 6.1             |
| 01/15/2025           | Updated Level 3 maximum generating size from 10 MW to 20 MW.  | 6.2             |

# Contents

|          |  |           |
|----------|--|-----------|
| <b>1</b> | <b>Introduction</b>  | <b>1</b>  |
| A        | General . . . . .  | 1         |
| B        | Small Generating Facility Levels . . . . .                                 | 1         |
| C        | Policy on Distribution Resources . . . . .                                 | 2         |
| D        | Codes and NERC Standards . . . . .   | 3         |
| E        | Generation Sources . . . . .   | 3         |
| F        | Parallel Operation . . . . .   | 3         |
| G        | Separate System . . . . .  | 4         |
| H        | Approval . . . . .   | 4         |
| I        | Net Metering . . . . .   | 4         |
| <b>2</b> | <b>CORE System Information</b>   | <b>5</b>  |
| A        | Voltage . . . . .  | 5         |
| B        | Circuit Restoration . . . . .  | 5         |
| C        | Signage Requirements . . . . .   | 5         |
| <b>3</b> | <b>Additional Requirements</b>   | <b>6</b>  |
| A        | Design Review . . . . .  | 6         |
| B        | PV and Inverter Systems . . . . .  | 6         |
| C        | Synchronous Generators and Induction Generators . . . . .                  | 7         |
| D        | Protection . . . . .   | 7         |
| <b>4</b> | <b>Qualifying Facilities</b>   | <b>7</b>  |
| A        | Definition of Qualifying Facilities . . . . .                              | 7         |
| B        | Protective Devices . . . . .   | 7         |
| C        | Effective Grounding . . . . .  | 8         |
| D        | Design Specifications . . . . .  | 8         |
| E        | Design Review and Documentation . . . . .                                  | 8         |
| F        | Multi-Inverter System . . . . .  | 8         |
| G        | Induction Generators . . . . .   | 8         |
| <b>5</b> | <b>General Operating Requirements</b>                                      | <b>9</b>  |
| A        | Anti-Islanding . . . . .   | 9         |
| B        | Production Meter . . . . .   | 9         |
| C        | Disconnecting from CORE Facilities . . . . .                               | 9         |
| D        | Revision, Replacement, or Design Change . . . . .                          | 9         |
| E        | Telemetry . . . . .  | 9         |
| <b>6</b> | <b>Effective Grounding</b>   | <b>10</b> |
| A        | Effective Grounding . . . . .  | 10        |
| B        | Ground Relays . . . . .  | 11        |
| C        | Grounding Bank Protection . . . . .  | 12        |
| D        | Non-effectively grounded Distribution Connected Interconnections . . . . . | 12        |
| E        | Inverters . . . . .  | 12        |

|           |   |           |
|-----------|---|-----------|
| <b>7</b>  | <b>Protective Relaying Requirements</b>                   | <b>12</b> |
| <b>8</b>  | <b>Demonstration of Protective Devices</b>                | <b>13</b> |
| <b>9</b>  | <b>System Integrity</b>                                   | <b>13</b> |
| A         | General . . . . .   | 13        |
| B         | Harmonics . . . . .                                       | 13        |
| C         | Voltage at Distribution Level . . . . .                   | 14        |
| <b>10</b> | <b>Metering Requirements</b>                              | <b>16</b> |
| A         | Meter Locations & AC Disconnects . . . . .                | 16        |
| B         | Meter Set & On-Site Inspection . . . . .                  | 16        |
| <b>11</b> | <b>Energy Storage</b>                                     | <b>17</b> |
|           | <b>Appendix A - Example Net Metering One Line Diagram</b> | <b>18</b> |
|           | <b>Appendix B - Example Level 2 One Line Diagram</b>      | <b>23</b> |
|           | <b>Appendix C - Signage</b>                               | <b>25</b> |
|           | <b>Definitions</b>  | <b>26</b> |

|  |                            |                                       |            |
|--|----------------------------|---------------------------------------|------------|
|  | <b>Operating Procedure</b> | Procedure No.                         | 750-02     |
|  |                            | Revision No.                          | 6.2        |
|  |                            | Effective Date                        | 01/15/2025 |
| <b>Small Generating Interconnection Guidelines</b>                               |                            | <b>Distribution Restriction: None</b> |            |

# 1 Introduction

## A General

These Small Generation Interconnection Guidelines (“Guidelines”) describe the requirements for the connection of generation and energy storage facilities with capacity of twenty (20) MW or less to CORE Electric Cooperative’s (“CORE”) electric distribution system (the “System”). These Guidelines document detailed technical requirements for interconnection that are in addition to the terms and requirements contained in CORE’s Small Generation Interconnection Procedures (Procedure No. 750-01) (“SGIP”) and its Small Generation Interconnection Agreement (“SGIA”). To the extent there is a conflict between the SGIP, the SGIA or these Guidelines, the provisions in the SGIP and SGIA shall control.

These Guidelines apply to all of CORE’s customers that attempt to connect any DERs (Distributed Energy Resources) (each an “Interconnection Customer”). The minimum provisions within this guideline are general and may not cover all the details required. They do not address all of the engineering requirements or complexities involved in designing a Small Generating Facility and associated protection scheme. The Interconnection Customer is responsible for the overall safe and effective design and operation of their Small Generating Facility.

Contact CORE Electric Cooperative for more information.

Contact Information:  
 CORE Electric Cooperative  
 Attn: Engineering Manager  
 5496 North US Hwy 85  
 Sedalia, CO 80135  
 303.688.3100

## B Small Generating Facility Levels

The term “Small Generating Facility” in these guidelines refers to any generating facility, Qualifying Facility, device, system or distributed resource which produces electricity with total nameplate generating capacity connected at one meter location less than twenty (20) MW (AC) that plans to interconnect to CORE’s System under either the Level 1 Process, Level 2 Process or Level 3 Process under the SGIP. These process titles (levels), per CPUC rule 3850, are internally used within CORE and are defined here for the interconnecting customer’s knowledge.

### 1. Level 1 Process

For certified inverter-based small generating residential class service where the total nameplate generating capacity connected at one meter location is twenty-five (25) kW (AC) or less, or a commercial class service where the total

|  |                            |                                       |            |
|--|----------------------------|---------------------------------------|------------|
|  | <b>Operating Procedure</b> | Procedure No.                         | 750-02     |
|  |                            | Revision No.                          | 6.2        |
|  |                            | Effective Date                        | 01/15/2025 |
| <b>Small Generating Interconnection Guidelines</b>                               |                            | <b>Distribution Restriction: None</b> |            |

nameplate generating capacity connected at one meter location is twenty-five (25) kW (AC) or less.

**2. Level 2 Process**

For inverter-based facilities no larger than five (5) MW (AC) or non-inverter-based facilities no larger than two (2) MW, but more than the Level 1 process requirements see section 4 Qualifying Facilities. Applicants who meet the requirements for a Level 2 process and pass specified screens may be eligible for a Fast Track Process. This is to be determined by CORE, after an interconnection application has been submitted.

**3. Level 3 Process**

For generating facilities producing twenty (20) MW (AC) or less, but more than the Level 2 process requirements see section 4 (Qualifying Facilities.)

**4. Large Generating Facility Process**

For generating facilities producing more than twenty (20) MW (AC), but less than or equal to eighty (80) MW (AC) measured at one meter. Refer to the Large Generating Interconnection Procedure (LGIP) Document.

**C Policy on Distribution Resources**

CORE will authorize “Parallel Systems Operation” (PSO) with CORE facilities for Interconnection Customer Small Generating Facilities. Such installations shall be installed with no adverse effects to the general public, CORE facilities or personnel, and other consumer’s equipment or personnel.

Protective devices (relays, circuit breakers, etc.), and metering equipment shall be installed at locations where an Interconnection Customer desires PSO. The purpose of the protective devices is to rapidly disconnect the Interconnection Customer’s equipment from CORE’s system when faults or abnormal operations occur. These devices are mutually beneficial to CORE and the Interconnection Customer; however, it is the responsibility of the Interconnection Customer to install the equipment necessary to protect its equipment. Modifications to CORE’s facilities may be required in order to accommodate PSO. These modifications will be done at the Interconnection Customer’s expense. Interconnection Customer shall discuss project plans with CORE before purchasing or installing equipment. There are portions of CORE’s system that are not suited to PSO without extensive system upgrades. All Small Generating Facilities must meet the standards set in IEEE 1547 and comply with latest edition of the NEC standards.

CORE has no responsibility, either direct or implied, for the protection of the Interconnection Customer’s equipment. It is fully the responsibility of the Interconnection Customer to protect its installation in such a manner that faults or other disturbances on CORE’s system shall not cause damage to the Interconnection Customer’s installation.

|  |                            |                                       |            |
|--|----------------------------|---------------------------------------|------------|
|  | <b>Operating Procedure</b> | Procedure No.                         | 750-02     |
|  |                            | Revision No.                          | 6.2        |
|  |                            | Effective Date                        | 01/15/2025 |
| <b>Small Generating Interconnection Guidelines</b>                               |                            | <b>Distribution Restriction: None</b> |            |

Inverters that have capabilities beyond the functionality needed to meet the IEEE 1547 (2003) are considered to be Smart Inverters. As long as the inverter can be certified under the present IEEE 1547.1 (2005) standard, the functionalities of the inverter described by the IEEE document may be used for certified interconnections.

Some abilities considered “smart inverter abilities” may be present but disabled. The additional abilities are to remain disabled unless CORE directs these abilities are to be enabled. As standards evolve, accommodate programming upgrades to become compliant with the advanced certification.

## D Codes and NERC Standards

The Interconnection Customer’s installation shall comply with all applicable national, state, and local construction and safety codes. (NERC, WECC, etc.)

The Interconnection Customer must provide access to the Point of Common Coupling (PCC) and the Disconnect Switch for CORE personnel at all times.

## E Generation Sources

An Interconnection Customer facility must produce 60 Hz sinusoidal alternating current at CORE’s standard voltage and phase rotation and meet all other operation requirements (harmonics, power quality, etc.) specified herein. These requirements are for any and all types of generation, and power storage (Batteries).

## F Parallel Operation

CORE requires a PSO facility to be connected to and operates in parallel with CORE’s System in order to transfer power between the Interconnection Customer and CORE’s system. A Hot Transfer system will typically parallel with CORE’s System for a short time to minimize the disturbance caused by switching between the two systems. Hot Transfer systems have the same interconnection requirements unless a failsafe interlocking system is approved by CORE and demonstrated to limit the parallel time to less than one (1) second.

CORE facilities are subjected to an assortment of environmental (lightning, wind, and ice) and man-made hazards. Short-circuits, grounded conductors, and open conductors are the electrical problems which are the outcome of these hazards. These fault conditions require that the equipment involved be de-energized within the time limit specifications of IEEE 1547 and IEEE 1547.1 because of the hazards they pose to the public and to the operation of the system. Interconnection Customer’s facilities shall have adequate protective devices to detect disturbances on CORE’s System and immediately disconnect from all sources.

PSO can also cause a condition known as “accidental isolating” or “islanding.” This condition is created when a portion of CORE’s load is isolated from CORE’s

|  |                            |                                       |            |
|--|----------------------------|---------------------------------------|------------|
|  | <b>Operating Procedure</b> | Procedure No.                         | 750-02     |
|  |                            | Revision No.                          | 6.2        |
|  |                            | Effective Date                        | 01/15/2025 |
| <b>Small Generating Interconnection Guidelines</b>                               |                            | <b>Distribution Restriction: None</b> |            |

system but is still connected to an Interconnection Customer’s facilities. Such load could continue to operate but at abnormal voltage and/or frequency. Correctly installed protective relaying, installed by the Interconnection Customer, shall prohibit accidental isolating or islanding. Protective devices are intended to disconnect the Small Generating Facility when disturbances occur. The requirements are minimal for Small Generating Facilities and increase with the complexity of the Interconnection Customer’s Small Generating Facility. General and specific requirements for PSO of various sizes are discussed in following sections.

## G Separate System

A separate system does not operate in parallel with CORE’s System. There shall be no possibility of connecting customer generation in parallel with CORE. This system can be arranged with either an electrical or mechanical switching arrangement which prevents CORE’s system from concurrently powering the same load as the customer’s small generation system. An ATO, Automatic Throw Over, service may be added for systems of parallel operation.

## H Approval

The terms “approve”, “approved”, and “approval” used within this guide means acceptance. Acceptance by CORE is not an endorsement of Interconnection Customer’s design, specifications or facility. Acceptance by CORE does not relieve the Interconnection Customer of any responsibility for the safety or reliability of the Interconnection Customer’s equipment.

If use of the Interconnection Customer’s facility should cause unusual fluctuation or disturbance on, or inductive interference with CORE’s facility or other CORE customer(s), then CORE shall have the right to require the Interconnection Customer to install, at the Interconnection Customer’s expense, suitable apparatus to correct such fluctuation, disturbance, or interference.

## I Net Metering

A net metered facility is defined as a certified inverter-based small generating residential class service where the total nameplate generating capacity connected at one meter location is the lesser of 200% of the twelve (12) month historical usage at the meter location or ten (10) kW (AC) or less, or a commercial class service where the total nameplate generating capacity connected at one meter location is the lesser of 200% of the twelve (12) historical usage at the meter location or twenty-five (25) kW (AC) or less.



|  |                            |                                       |            |
|--|----------------------------|---------------------------------------|------------|
|  | <b>Operating Procedure</b> | Procedure No.                         | 750-02     |
|  |                            | Revision No.                          | 6.2        |
|  |                            | Effective Date                        | 01/15/2025 |
| <b>Small Generating Interconnection Guidelines</b>                               |                            | <b>Distribution Restriction: None</b> |            |

## 2 CORE System Information

### A Voltage

Primary distribution voltage for CORE is 12.47 kV effectively grounded 4 wire facilities. Secondary and service voltages will vary depending on the location. Three phase power lines and facilities do not exist at all locations in CORE service territory. Interconnection Customer shall contact CORE for specific circuit information where the Interconnection Customer’s facility is proposed.

### B Circuit Restoration

Because most faults on overhead lines are of a temporary nature, it is the general practice of CORE to reclose its protection equipment (reclosers and circuit breakers) on the distribution facilities between 1.5 and 10.0 seconds after automatically tripping open. Relaying shall be installed by the Interconnection Customer to disconnect the generating facility(s) from CORE’s faulted or isolated facilities before the reclosing operation. During a reclosing operation there is some risk that the Interconnection Customer’s relaying is inadequate or too slow to separate the systems before the reclosing operation. The Interconnection Customer may desire added protection to mitigate such risk. The Interconnection Customer is obligated to ascertain the necessity for this added protection. All design, materials, construction costs and ongoing maintenance costs associated with the added protection will be done at the expense of the Interconnection Customer. The Interconnection Customer is responsible for ensuring proper disconnection of systems.

To address the hazards associated with out of sync reclosing VSR, Voltage-Supervision-of-Reclosing, also referred to as HLRB, Hot-line reclose blocking, will be required whenever a feeder or line segment may have revers power flow, at least part time, during the year.

### C Signage Requirements

CORE requires signage to be installed with bright yellow background, made from plastic laminate, mounted with permanent adhesive or rivets on the disconnect switch cover or immediately adjacent to the disconnect in a location clearly visible. Signage shall be 2” x 4<sup>3</sup>/<sub>4</sub>” in size with 36 point Arial Bold font. The placard shall match the size and lettering illustrated as close as practical. See Appendix “C” for more details.

|  |                            |                                       |            |
|--|----------------------------|---------------------------------------|------------|
|  | <b>Operating Procedure</b> | Procedure No.                         | 750-02     |
|  |                            | Revision No.                          | 6.2        |
|  |                            | Effective Date                        | 01/15/2025 |
| <b>Small Generating Interconnection Guidelines</b>                               |                            | <b>Distribution Restriction: None</b> |            |

### 3 Additional Requirements

#### A Design Review

Each application will be reviewed by CORE’s Engineering Department. All devices must be Underwriters Laboratory (UL)-approved, IEEE 1547 compliant, and designed to meet the latest edition of NEC standards.

The installation must be permanently wired into a suitable load center. A lockable disconnect, near the utility meter, must be provided that is readily accessible at all times to CORE’s personnel (See Section 10A for additional information).

Refer to Appendix A for an example net metering one-line. The one-lines included in this document are intended to provide guidelines for minimum protection of CORE’s System. CORE protection requirements are not for the protection of Interconnection Customer’s equipment. The Interconnection Customer is responsible for the design and protection of its own facility and equipment.

#### B PV and Inverter Systems

Inverter systems can be harmonic sources. Section 9.B specifies allowed limits of harmonic distortion and interference. If an Interconnection Customer’s equipment is found to be interfering with CORE’s system, other Interconnection Customers, or public communications, the interfering Interconnection Customer will be required to install filtering or other corrective measures to bring the harmonic output of the inverter to within the values specified in Section 9. The inverter must provide power between 0.95 lagging to 0.95 leading power factor.

Line commutated inverter systems are the required design for interconnection to CORE’s system. These systems, by design, will disconnect when CORE’s voltage source is removed.

Self-commutated inverter systems will self-excite and could back-feed into CORE’s system and must meet the same requirements as induction generators. The energizing of a de-energized circuit is discussed in Section 5.A and is not allowed.

CORE also requires that the interconnecting customer display placards showing “Alternative Power Source” at the disconnect. This signage shall be provided by the solar installers. See Appendix C for all signage and more information.

All three phase systems that use single phase inverters are subject to disconnect, and will cease exporting power, on the condition that one single phase trips or a single phase has been lost. This includes any facility that is large enough to require a grounding bank.

These facilities shall be designed to produce power that is nearly balanced between each phase. If interconnected generation has become unbalanced, it shall be disconnected from CORE’s system, until re-balancing has been established.

Smart inverters will be allowed in customer interconnections if they meet the

|  |                            |                                       |            |
|--|----------------------------|---------------------------------------|------------|
|  | <b>Operating Procedure</b> | Procedure No.                         | 750-02     |
|  |                            | Revision No.                          | 6.2        |
|  |                            | Effective Date                        | 01/15/2025 |
| <b>Small Generating Interconnection Guidelines</b>                               |                            | <b>Distribution Restriction: None</b> |            |

current standard for inverters. For smart inverter abilities and requirements, see telemetry section 5.E.

This system type shall be grounded using effective grounding methods, see section 6.A. This may be comprised of a single ground reference installed for the entire system.

## C Synchronous Generators and Induction Generators

Interconnecting customers connecting synchronous or induction generators shall be required to fill out the information in the level 2 application. This information shall be reviewed by CORE’s engineering department, and shall be metered as net metering if generation production qualifies as net metering.

For induction generator installations with a total generating capacity of 5 kW or less, CORE will supply the VAR requirements from general system sources without a charge to the Interconnection Customer. Installations over 5 kW capacity will require devices to be installed to maintain a power factor greater than 95%, over all output ratings. Such devices will be at the expense of the Interconnection Customer.

## D Protection

Overcurrent protection shall be required in accordance with the latest edition of the NEC standards.

# 4 Qualifying Facilities

## A Definition of Qualifying Facilities

A Qualifying Facility is defined as any interconnecting facility that produces more than 25 kW of renewable energy, but less than twenty (20) MW of renewable energy.

## B Protective Devices

Protective devices (relays, circuit breakers, etc.) for the protection of CORE’s System shall be installed as required by CORE. The attached one-line diagrams show general arrangement. A detailed one-line diagram shall be submitted with the application.

A manual disconnecting device, which shall include a lockable disconnect and a visible open, must be provided. The device must be readily accessible to and operable by CORE personnel at all times. The location of the disconnecting device shall be near the meter location and be readily accessible to CORE personnel at all times and shall be labeled “Utility Disconnect Switch”.

|  |                            |                                       |            |
|--|----------------------------|---------------------------------------|------------|
|  | <b>Operating Procedure</b> | Procedure No.                         | 750-02     |
|  |                            | Revision No.                          | 6.2        |
|  |                            | Effective Date                        | 01/15/2025 |
| <b>Small Generating Interconnection Guidelines</b>                               |                            | <b>Distribution Restriction: None</b> |            |

## C Effective Grounding

Generating facilities must maintain effective grounding (see Section 6 Effective Grounding)

## D Design Specifications

Interconnection Customers are required to submit detailed design specifications and engineering information as specified in the CORE document 750-01, Small Generation Interconnection Procedure (SGIP).

## E Design Review and Documentation

Design review will follow the process as specified in the CORE document 750-01 SGIP.

CORE also requires that the interconnecting customer display placards showing “Alternative Power Source” at the disconnect. These placards shall be permanently installed and weatherproof and shall be provided by the solar installers. See Appendix C for all signage and more information.

## F Multi-Inverter System

Multi-Inverter system types shall be grounded using effective grounding methods, see section 6.A. All inverters shall provide power between 0.95 lagging to 0.95 leading power factor. Ideally inverters shall provide a power factor at unity.

## G Induction Generators

Installations shall maintain power factor greater than 95% overall output ratings. Power factor correction equipment will be at the expense of the Interconnection Customer.

Under certain conditions a self-excited induction generator can produce abnormally high voltages which can cause damage to the equipment of other Interconnection Customers and other non-interconnection customers. Overvoltage relays can limit the duration of such high voltages but cannot control their magnitude. Because of these problems, the reactive power supply for large induction generators must be studied on an individual basis.

In general, self-excitation problems are most likely in rural areas where CORE’s system capacity and load density are low.

It is particularly important to contact CORE to determine if an induction generator can be connected to an existing distribution line. Where self-excitation problems appear likely, special service arrangements will be required. In many cases, the additional expense for such special service methods will outweigh the cost savings associated with induction generators. Especially during

|  |                            |                                       |            |
|--|----------------------------|---------------------------------------|------------|
|  | <b>Operating Procedure</b> | Procedure No.                         | 750-02     |
|  |                            | Revision No.                          | 6.2        |
|  |                            | Effective Date                        | 01/15/2025 |
| <b>Small Generating Interconnection Guidelines</b>                               |                            | <b>Distribution Restriction: None</b> |            |

self-excitation, it is important for a facility to meet the effective grounding requirements to restrict the range of voltage imbalance.

## 5 General Operating Requirements

### A Anti-Islanding

CORE has a strict Anti-Islanding policy.

Interconnection Customers shall not energize a de-energized CORE circuit(s). Interconnection Customers will be liable for any accident, injury, or damage resulting from an intentional or unintentional energizing of CORE circuits in accordance with the terms of these Guidelines, the SGIP and SGIA.

Interconnection Customers will be disconnected immediately for energizing a de-energized circuit and will not be reconnected until all issues that resulted in the action are resolved to the satisfaction of CORE.

### B Production Meter

Each interconnecting facility, except net metering, shall require a production meter. This meter will be supplied by CORE.

### C Disconnecting from CORE Facilities

Interconnection Customers shall disconnect from CORE’s facilities when requested for routine maintenance of CORE’s equipment, if the Interconnection Customer’s generating equipment is interfering with other CORE customers on the system, or if notified by CORE that system conditions require the removal of generation. CORE shall disconnect Interconnection Customer manually or automatically, without notice, for system emergencies.

For larger generation, if an Interconnection Customer is disconnecting from CORE’s facilities for its own purposes, Interconnection Customers shall notify CORE prior to disconnecting.

### D Revision, Replacement, or Design Change

Any change to the Interconnection Customer’s facility that affects the output, major components, or critical systems protection must be approved in writing by CORE prior to the changes taking place.

### E Telemetry

Monitoring and controlling interconnecting systems is essential to creating a more reliable system as more interconnections are created. As the production of smart inverters increase, standards will evolve. With this growing technology smarter

|  |                            |                                       |            |
|--|----------------------------|---------------------------------------|------------|
|  | <b>Operating Procedure</b> | Procedure No.                         | 750-02     |
|  |                            | Revision No.                          | 6.2        |
|  |                            | Effective Date                        | 01/15/2025 |
| <b>Small Generating Interconnection Guidelines</b>                               |                            | <b>Distribution Restriction: None</b> |            |

security systems shall also be set in place. CORE will require that all levels of PSO will be required to have advanced interconnections with larger facilities being required to have telemetry with increased cyber security.

Smart inverters currently contain excess capabilities, greater than that of the standard inverter. The current standard held by CORE requires these capabilities to be disabled unless specified otherwise by CORE’s Engineering Department. Level one interconnections’ requirement of telemetry is at the discretion of CORE. If telemetry is required by CORE, the interconnecting customer shall dedicate space for telemetry equipment. The amount of space to be dedicated depends on what equipment is purchased by the interconnecting customer which meets CORE’s minimum requirements.

All level 2 interconnections will require telemetry with the ability to monitor output power (active and reactive), voltage, and interconnection status. The interconnecting customer is responsible for dedicating space for telemetry equipment. The amount of space to be dedicated depends on what equipment is purchased by the interconnecting customer, which meets CORE’s minimum requirements. Additionally at the sole discretion of CORE some level 2 interconnections may be required to install cyber security features at the interconnecting customer’s expense.

All large generation facilities, level 3, shall be required to have telemetry within the system, at the interconnecting customer’s expense, with an increased amount of cyber security as deemed appropriate by CORE. With this connected telemetry system, CORE will have the right and may disconnect generation at any time. CORE may also change control modes with the given telemetry. The telemetry’s main purpose is to send information, at near real time, about the interconnection status. The interconnecting customer is responsible for dedicating space for telemetry equipment. The amount of space to be dedicated depends on the equipment purchased by the interconnecting customer, which meets CORE’s minimum requirements.

## 6 Effective Grounding

### A Effective Grounding

CORE maintains effective grounding on the distribution system and requires that all Interconnection Customers design their systems so that they contribute to maintaining an effectively grounded system. Effective grounding limits the voltage rise, typically to 130%, on un-faulted phases during single-line to ground fault conditions. To achieve this, an Interconnection Customer’s facility equivalent impedance (Thevenin equivalent impedance) shall meet the following criteria (reference IEEE Std 142-2007):

1. The positive sequence reactance must be greater than the zero sequence resistance ( $X1 > R0$ );

|  |                            |                                       |            |
|--|----------------------------|---------------------------------------|------------|
|  | <b>Operating Procedure</b> | Procedure No.                         | 750-02     |
|  |                            | Revision No.                          | 6.2        |
|  |                            | Effective Date                        | 01/15/2025 |
| <b>Small Generating Interconnection Guidelines</b>                               |                            | <b>Distribution Restriction: None</b> |            |

2. The zero sequence reactance must be greater than or equal to two and one-half ( $2\frac{1}{2}$ ) times the positive sequence reactance and less than or equal to three (3) times the positive sequence reactance ( $2.5X1 \leq X0 \leq 3.0X1$ ).

When calculating the effective grounding networks, the networks should include the impedance for the following: The step-up transformer, generator subtransient reactance, neutral grounding on the step-up transformer and/or generator, cable runs greater than 50 feet in length and the grounding bank.

There are many different system configurations that will meet the effective grounding requirements. Common guidelines and restrictions include, but are not limited to, the following:

1. Step-up transformer with grounded-wye high side and low side with a grounding bank or the neutral grounded with a reactor.
2. Step-up transformer with a delta generator and a grounded-wye system must have a reactor in its grounded-wye neutral connection.
3. Line voltage producing generators, not using a step-up transformer, shall be adequately grounded (with grounding reactor in generator neutral) or use a grounding bank.
4. The interconnecting customer's equipment must be able to withstand and operate during an allowable 4% of voltage imbalance which will cause a substantial current flow into the customer's generators and grounding devices.

Interconnection Customer shall consult CORE for normal source impedance and current and voltage imbalance data for a given location before purchasing equipment to ensure all devices are properly rated. Both steady state and short time duty shall be considered. Normal source is the ordinary arrangement of CORE's facility, while a temporary source, due to maintenance, construction, or emergency activities, will alter the source impedance of an Interconnection Customer facility. Future changes to CORE's system can impact the Interconnection Customer's system. Any changes to the Interconnection Customers system that are required to meet CORE's system changes are the responsibility of the Interconnection Customer.

Solidly grounded generators can be harmonic sources or sinks and should be avoided. Generators that cannot tolerate severe phase current imbalance shall have a grounding bank.

## B Ground Relays

When an Interconnection Customer's facility is operating in parallel with a CORE facility, the ground relays associated with CORE's substation will become de-sensitized during a single-line to ground fault. To maintain protection of CORE's facilities, the Interconnection Customer shall not limit CORE's contribution to a single-line to ground fault to less than 90% of the value without the Interconnection Customer's ground source on line.



|  |                            |                                       |            |
|--|----------------------------|---------------------------------------|------------|
|  | <b>Operating Procedure</b> | Procedure No.                         | 750-02     |
|  |                            | Revision No.                          | 6.2        |
|  |                            | Effective Date                        | 01/15/2025 |
| <b>Small Generating Interconnection Guidelines</b>                               |                            | <b>Distribution Restriction: None</b> |            |

Before an Interconnection Customer selects a site and purchases equipment, CORE recommends that the Interconnection Customer’s plans be reviewed by CORE’ Engineering Department. CORE may limit an Interconnection Customer from adding generation to certain feeders due to system requirements and/or protection issues.

## C Grounding Bank Protection

Grounding banks may be used for a ground reference for transformers. This protection must be compliant with the NESC, NEC, and IEEE standards. The system must be de-energized, or have been tripped offline when the grounding bank has failed. As referred to above generators that cannot tolerate severe phase current imbalance shall have a grounding bank.

## D Non-effectively grounded Distribution Connected Interconnections

At CORE’s discretion delta generators under 100kW, may be used if at all times the islanded generator load is greater than two (2) times larger on each phase than the generator per phase kW rating.

Grounding is required even when anticipated relaying will take the islanded generator offline in 30 cycles or less. This will preclude an ungrounded source from serving CORE load for any length of time and/or providing extremely high voltage to other CORE consumers on the same feeder as the Interconnection Customer.

## E Inverters

Inverters that don’t use a transformer and are rated above 100kW shall be assigned a separate ground reference.

# 7 Protective Relaying Requirements

CORE maintains a Transfer Trip, no “Ride Through”, policy.

CORE shall not be liable for any equipment beyond the meter. All relaying requirements will vary based on generating facility type and size. All relaying requirements given by CORE shall be given during the interconnection study process. Any protective relaying installed, in addition to CORE’s requirements, by the interconnecting customer shall be shown on the one line-one-line diagrams. IEEE document 1547.2 contains IEEE document 1547.2 contains default relay settings for interconnected facilities.

CORE always requires a visible disconnect. Manual disconnecting equipment capable of interrupting maximum available fault current shall be accessible at all



|  |                            |                                       |            |
|--|----------------------------|---------------------------------------|------------|
|  | <b>Operating Procedure</b> | Procedure No.                         | 750-02     |
|  |                            | Revision No.                          | 6.2        |
|  |                            | Effective Date                        | 01/15/2025 |
| <b>Small Generating Interconnection Guidelines</b>                               |                            | <b>Distribution Restriction: None</b> |            |

times, to CORE personnel. Such equipment shall be capable of being locked in an open position by CORE.

## 8 Demonstration of Protective Devices

One month (minimum) prior to an Interconnection Customer demonstrating the operation of the generation equipment, a written testing procedure outlining the testing of relay(s), breaker(s), generator(s), voltage, and VAR requirements shall be provided to CORE. CORE will witness sufficient testing to make a determination of the safe operation of the Interconnection Customer’s facility. These tests shall include, but are not limited to, trip checks, calibration checks and in-service checks. The Interconnection Customer is responsible for providing qualified personnel and equipment to perform all testing. When a satisfactory witness test is complete the unit can be released for PSO.

Any required protective device will be deemed required, after the facilities study has been completed. At that time, it is the interconnecting customer’s responsibility to install any piece(s) of equipment that meet the requirements for proper protection.

## 9 System Integrity

### A General

Interconnection of Interconnection Customer’s facilities with CORE facilities shall not cause a reduction in the quality of service to other CORE consumers. Interconnection Customer’s facilities shall not cause abnormal voltages, harmonics, frequencies, interruptions or in any way reduce the quality of service that CORE provides to its customers. Interconnection Customer shall immediately disconnect from CORE facilities if notified that CORE receives a complaint of high or low voltage, transient voltage, voltage distortion or harmonics. The Interconnection Customer will be allowed to reconnect to CORE facility after the Interconnection Customer has resolved the problem as reasonably determined by CORE. It is the responsibility of the Interconnection Customer to maintain the generating facility in good working order so that the voltage, Total Harmonic Distortion (“THD”), power factor, and VAR requirements are continually met.

### B Harmonics

Harmonics on the power system from all sources shall be minimized. The total harmonic distortion (“THD”) from the interconnection equipment shall be measured at the interconnecting customer’s point of common coupling (“PCC”). The Interconnection Customer must not exceed the harmonic current or voltage distortion values

|  |                            |                                       |            |
|--|----------------------------|---------------------------------------|------------|
|  | <b>Operating Procedure</b> | Procedure No.                         | 750-02     |
|  |                            | Revision No.                          | 6.2        |
|  |                            | Effective Date                        | 01/15/2025 |
| <b>Small Generating Interconnection Guidelines</b>                               |                            | <b>Distribution Restriction: None</b> |            |

in the IEEE Std.1547. The following Tables are reprinted from IEEE Std. 1547-2003. Certified Inverters that are operating properly will meet this requirement.

| Individual harmonic order h(odd harmonics) <sup>b</sup> | h<11 | 11≤h<17 | 17≤h<23 | 23≤h<35 | 35≤h | Total Demand Distortion (TDD) |
|---|------|---------|---------|---------|------|-------------------------------|
| Percent %   | 4.0  | 2.0     | 1.5     | 0.6     | 0.3  | 5.0                           |

Table 3 - Maximum harmonic current distortion in percent of current ( $I$ )<sup>a</sup>

<sup>a</sup>  $I$  = the greater of the Local EPS maximum load current integrated demand (15 or 30 minutes) without the DR unit, or the DR unit rated current capacity (transformed to the PCC when a transformer exists between the DR unit and the PCC).

<sup>b</sup> Even harmonics are limited to 25% of the odd harmonic limits above.

| Individual harmonic order | h<11 | 11≤h<17 | 17≤h<23 | 23≤h<35 | 35≤h | Total Demand Distortion (TDD) |
|---------------------------|------|---------|---------|---------|------|-------------------------------|
| Percent %                 | 4.0  | 2.0     | 1.5     | 0.6     | 0.3  | 5.0                           |

Table 6 - Maximum harmonic voltage distortion in percent of rated voltage

Any interference with customers or communications caused by Interconnection Customer's harmonics in excess of federal, state and local codes shall be resolved at the expense of the Interconnection Customer.

## C Voltage at Distribution Level

Operation of Interconnection Customer's Small Generating Facility shall not adversely affect the voltage stability of CORE's system. Adequate voltage control shall be provided by the Interconnection Customer to minimize voltage deviation on CORE's system caused by changing generating facility source or loading conditions. Automatic power factor or VAR controllers shall be provided for installations using synchronous generators. All generating facility installations greater than five (5) kW shall maintain a Power Factor greater than 95%, over all operating ranges, during all hours of operation. Operation with a leading power factor (VARs to generating facility) is a function of generating facility design and manufacturers rating and difficult for the Interconnection Customer to control. However, if an Interconnection Customer's facility is operating with a power factor less than 95% leading or lagging, the Interconnection Customer shall be

|  |                            |                                       |            |
|--|----------------------------|---------------------------------------|------------|
|  | <b>Operating Procedure</b> | Procedure No.                         | 750-02     |
|  |                            | Revision No.                          | 6.2        |
|  |                            | Effective Date                        | 01/15/2025 |
| <b>Small Generating Interconnection Guidelines</b>                               |                            | <b>Distribution Restriction: None</b> |            |

responsible for installing reactive power compensation to improve the overall power factor to greater than 95%. Power factor requirements shall be met at the PCC during all hours of operation and overall operating conditions.

Adequate generating facility reactive power shall be installed to withstand the normal voltage changes on CORE’s system. To ensure proper coordination of voltages and regulator operations the generating facility voltage VAR schedule, voltage regulator and transformer ratings (with taps if applicable) will be jointly determined by Interconnection Customer and CORE.

All new interconnection inverters shall be able to accommodate power factor settings at greater than 95%. The customer is responsible for either upsizing the inverter to be adequate to the operate at 95% PF, while producing the desired maximum real power; or as a result accept any real power reduction that may occur. If an existing installation needs to replace its inverter, the same requirements as a brand-new inverter system shall be met. An existing failed inverter may be repaired and reinstalled. All inverter installations shall be checked for effective grounding, see section 6.A.

CORE is not responsible for the protection of the customer’s equipment; however, CORE shall review the settings of the interconnecting customers synchronizing and protection relaying to be sure that it meets standards held by CORE for synchronous and induction generators.

Induction generator starts which adversely impact CORE’s system voltage shall limit voltage changes and bring the unit to synchronous speed before connecting to CORE’s system using step-switched capacitors or other techniques. Double-fed induction generators should use self-excitation to be brought to synchronous speed. Voltage fluctuations must be considered when connecting an induction generator. See voltage flicker below.

Interconnection Customer created voltage flicker (magnitude and frequency) shall not exceed the values given by the IEEE 1453 flicker curve chart. Voltage flicker percentage is referenced to generating facility pre-synchronize or motor pre-start conditions. CORE consumers may have voltage sensitive loads; therefore, if CORE receives complaints related to Interconnection Customer’s operation, the Interconnection Customer shall be responsible for reducing voltage variations even if the current operation is within the guidelines.

Voltage flicker is normally measured at the point of common coupling (PCC) between the Interconnection Customer and CORE. If voltage flicker problems occur, CORE may also take measurements at the nearest consumers.

The Interconnection Customer is responsible for all associated damage caused to the equipment of other CORE consumers due to voltage flicker issues. It is suggested that the Interconnection Customer review the “Computer Business Equipment Manufacturer’s Association” (“CBEMA”) curve detailed in IEEE/ANSI Standard 446-1995, Figure 3-4, for typical equipment sensitivity to very short voltage disturbances.

|  |                            |                                       |            |
|--|----------------------------|---------------------------------------|------------|
|  | <b>Operating Procedure</b> | Procedure No.                         | 750-02     |
|  |                            | Revision No.                          | 6.2        |
|  |                            | Effective Date                        | 01/15/2025 |
| <b>Small Generating Interconnection Guidelines</b>                               |                            | <b>Distribution Restriction: None</b> |            |

Metering requirements will vary depending on the size and configuration of the Interconnection Customer’s equipment. Metering will be specified and installed by CORE; all cost will be borne by the Interconnection Customer.

## 10 Metering Requirements

All metering of certified inverter-based small generating residential class services where the total nameplate generating capacity connected at one meter location is the lesser of 200% of the twelve (12) month historical usage at the meter location or ten (10) kW (AC) or less, or commercial class services where the total nameplate generating capacity connected at one meter location is the lesser of 200% of the twelve (12) historical usage at the meter location or twenty-five (25) kW (AC) or less that utilize Eligible Energy Resources will be net metering installations per CORE’s Rules and Regulations.

If other CORE metering is required for operation of the Small Generating Facility, the metering will be provided by CORE.

Meters shall be accessible to CORE at all times. CORE requires 48” of space in front of the meter housing. No equipment shall be placed directly above the utility meter housing.

### A Meter Locations & AC Disconnects

CORE requires PV meters (if applicable) and/or AC disconnects to be near the utility meter, and readily accessible (e.g., ahead of any fencing, gate(s), etc.). The exceptions are when the utility meter is on a pedestal or pole, in which case, CORE requires the PV meter (if applicable) and AC disconnects to be near the utility meter or on the front 25% of the house, and readily accessible (e.g., ahead of any fencing, gate(s), etc.). Solar equipment cannot be placed above the meter housing.

### B Meter Set & On-Site Inspection

CORE personnel shall witness testing of the following requirements before final approval is granted:

1. Verify power operation with no back feed to the utility (anti-islanding).
2. Verify visible, lockable disconnect.
3. Verify signage on meter housing disconnect switch, and transfer switch as specified in Appendix C - Signage
4. Verify inverter programming that will not allow electrical power export from energy storage devices to the grid.

|  |                            |                                       |            |
|--|----------------------------|---------------------------------------|------------|
|  | <b>Operating Procedure</b> | Procedure No.                         | 750-02     |
|  |                            | Revision No.                          | 6.2        |
|  |                            | Effective Date                        | 01/15/2025 |
| <b>Small Generating Interconnection Guidelines</b>                               |                            | <b>Distribution Restriction: None</b> |            |

## 11 Energy Storage

The interconnecting customer may choose to implement energy storage into their system.

If the storage system is charged from renewable generation, then it may participate in power exportation to the grid. Any storage facility that is not charged from renewable generation may not participate in power exportation. However, the interconnecting customer can still use the storage facility to power their main electrical breaker.

All storage device specifications shall be given with each interconnection application. Each device shall be represented on the generating facility one-line diagram.

See procedure 750-03, Energy Storage Procedure for details.

|  |                            |                                       |            |
|--|----------------------------|---------------------------------------|------------|
|  | <b>Operating Procedure</b> | Procedure No.                         | 750-02     |
|  |                            | Revision No.                          | 6.2        |
|  |                            | Effective Date                        | 01/15/2025 |
| <b>Small Generating Interconnection Guidelines</b>                               |                            | <b>Distribution Restriction: None</b> |            |

## Appendix A - Example Net Metering One Line Diagram

THIS PAGE INTENTIONALLY LEFT BLANK

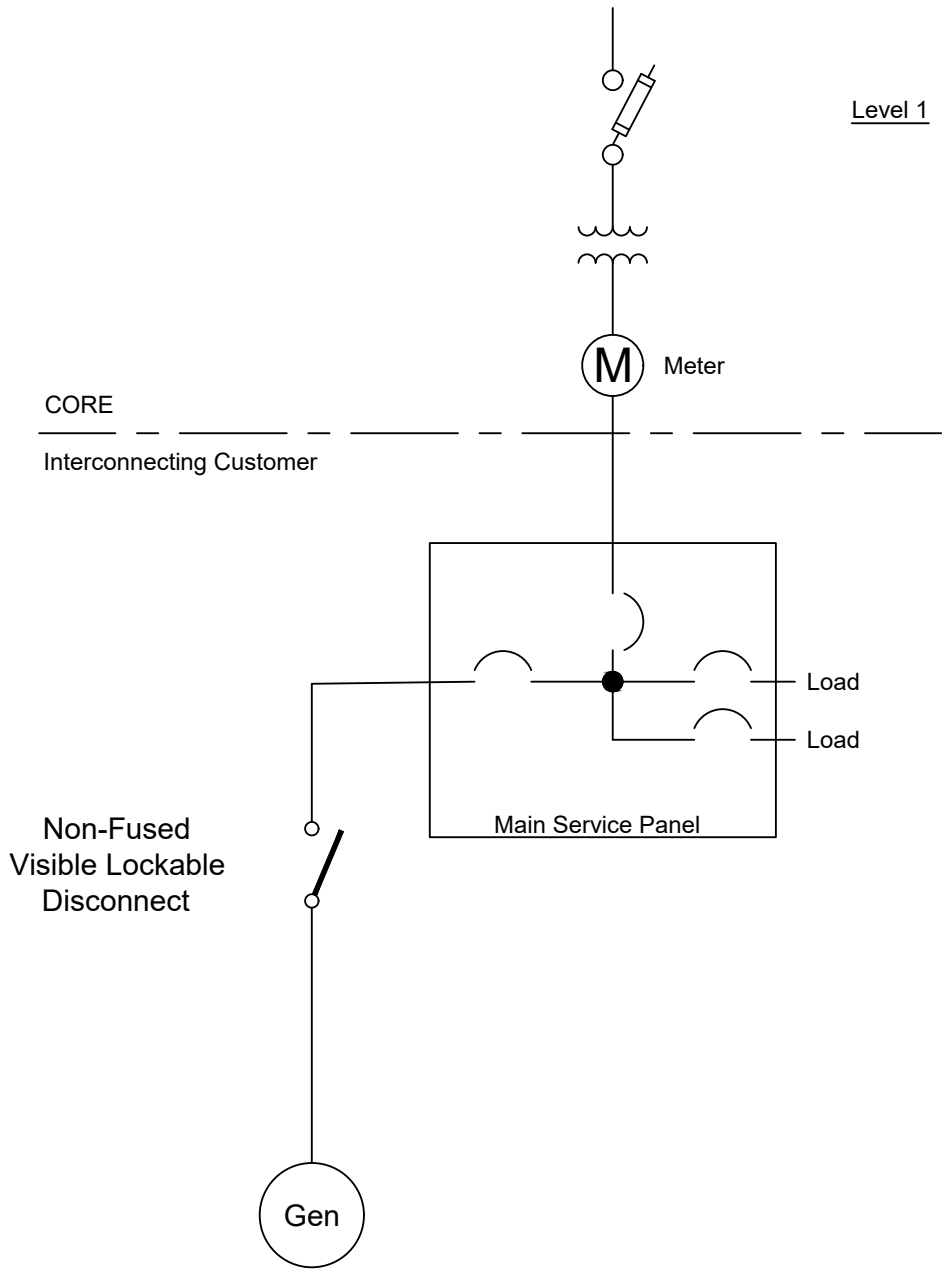

Example Level 1 Net-Metered  
One Line Diagram

APRIL 2024



DRAWN BY

ATS

APPROVED BY

|  |  |
|--|--|
|  |  |
|--|--|

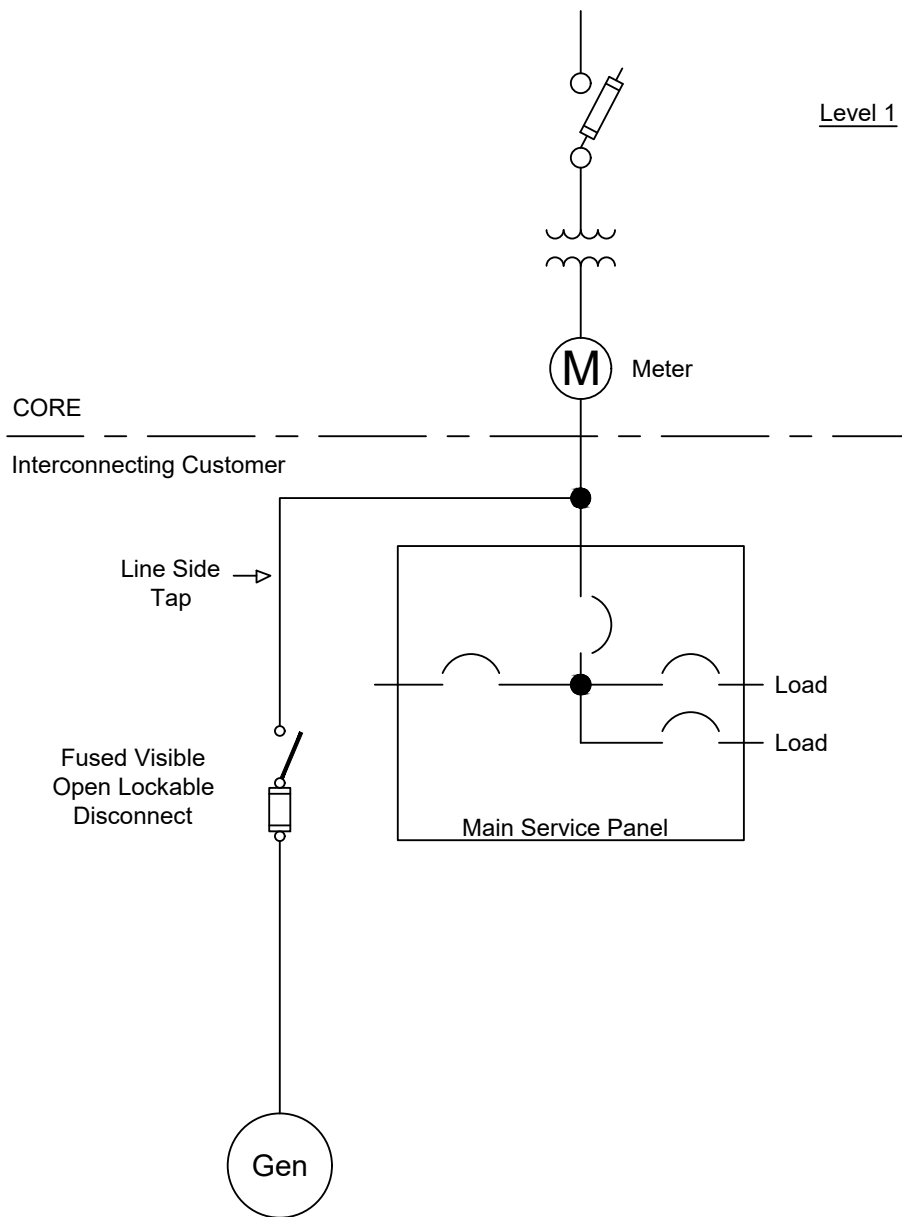

Example Level 1 Net-Metered  
Line Side Tap One Line Diagram

APRIL 2024



DRAWN BY

ATS

APPROVED BY



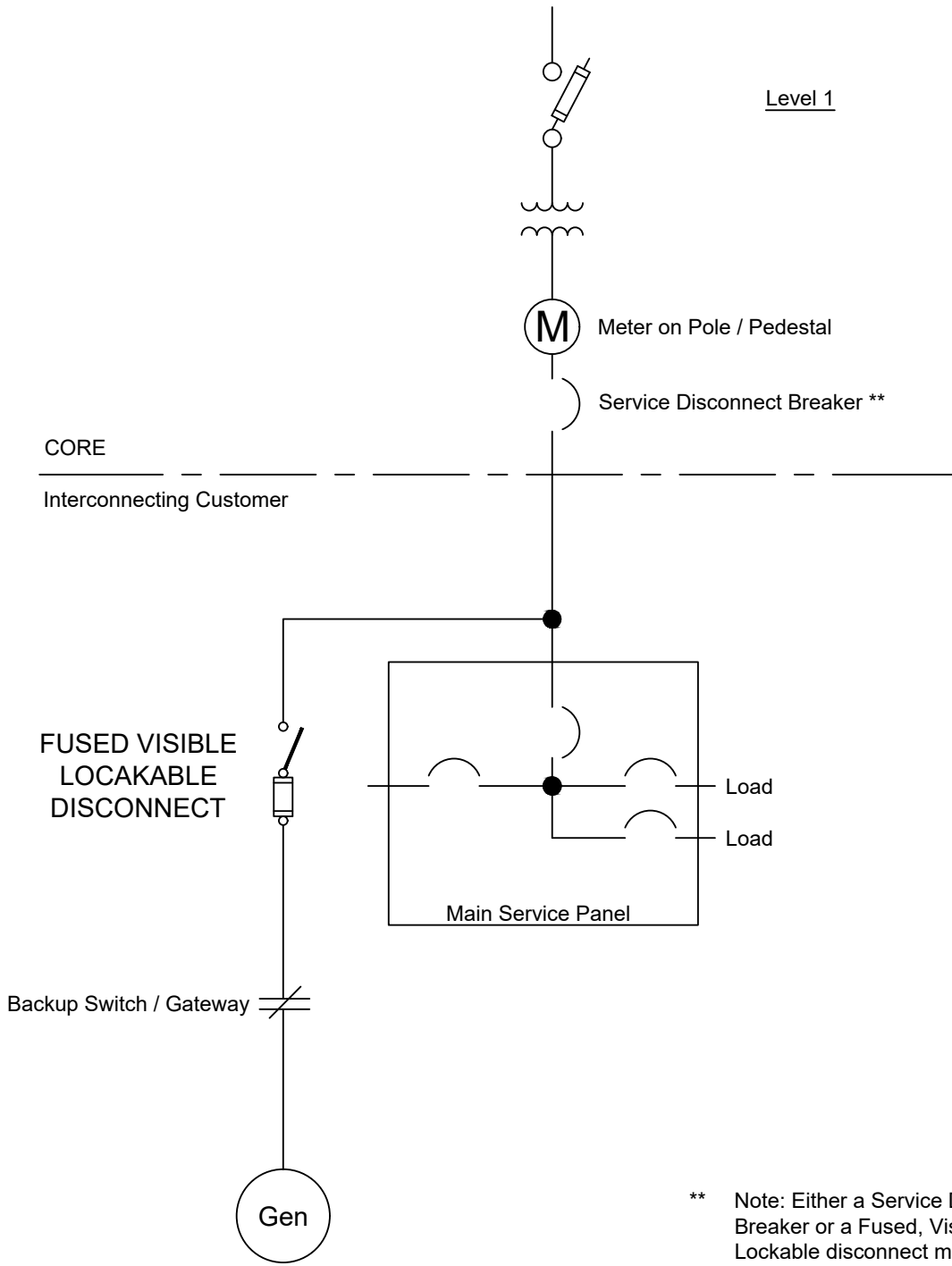

\*\* Note: Either a Service Disconnect Breaker or a Fused, Visible, Lockable disconnect must be installed in front of the backup switch or gateway on a line side tap

Example Level 1 Net-Metered Pole / Pedestal One Line Diagram

APRIL 2024

DRAWN BY  
 ATS  
 APPROVED BY

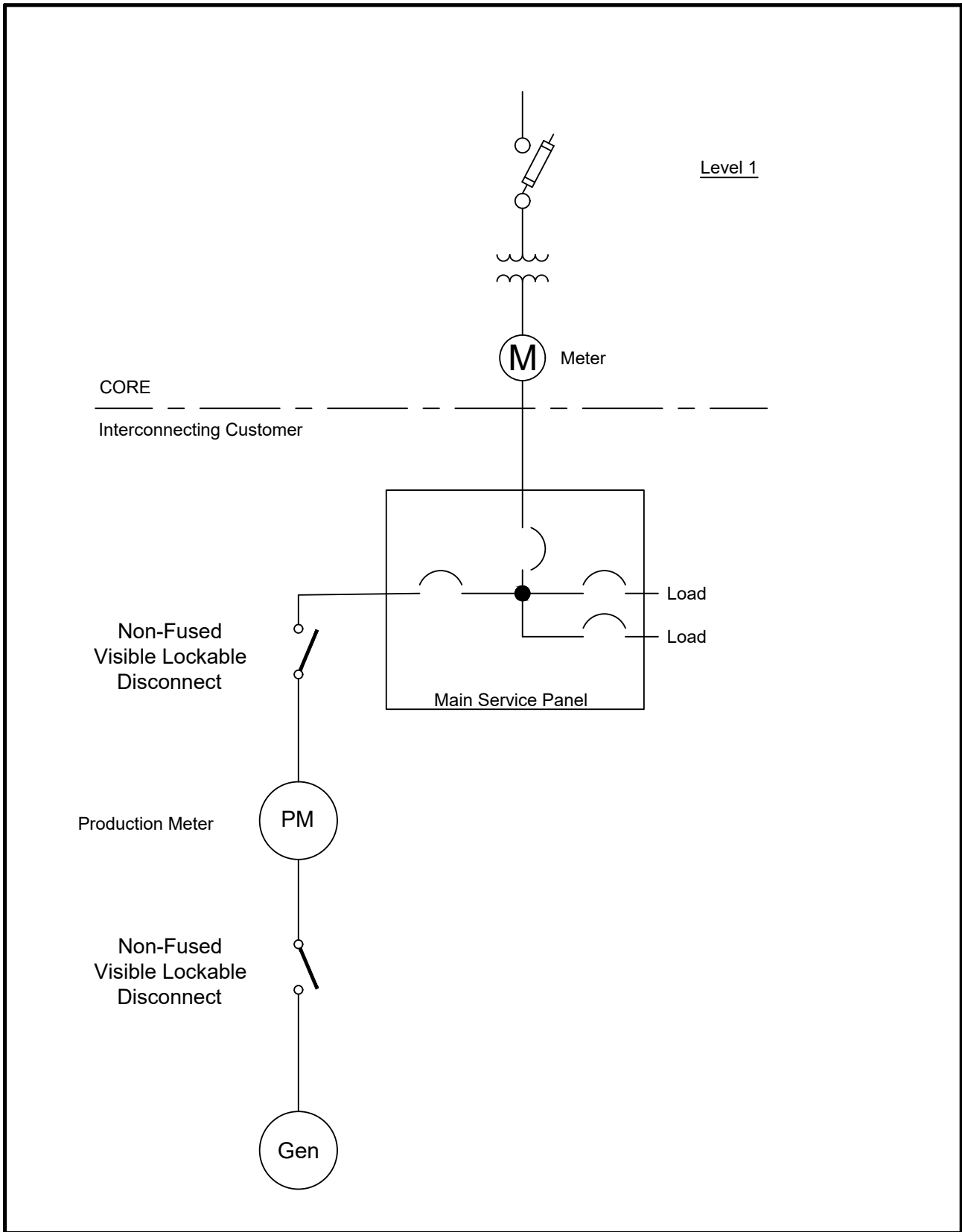

Example Level 1 Net-Metered Production Meter (Optional) One Line Diagram

|            |                 |  |  |
|------------|-----------------|--|--|
| APRIL 2024 | DRAWN BY<br>ATS |  |  |
|            | APPROVED BY     |  |  |

|  |                            |                                       |            |
|--|----------------------------|---------------------------------------|------------|
|  | <b>Operating Procedure</b> | Procedure No.                         | 750-02     |
|  |                            | Revision No.                          | 6.2        |
|  |                            | Effective Date                        | 01/15/2025 |
| <b>Small Generating Interconnection Guidelines</b>                               |                            | <b>Distribution Restriction: None</b> |            |

## Appendix B - Example Level 2 One Line Diagram

THIS PAGE INTENTIONALLY LEFT BLANK

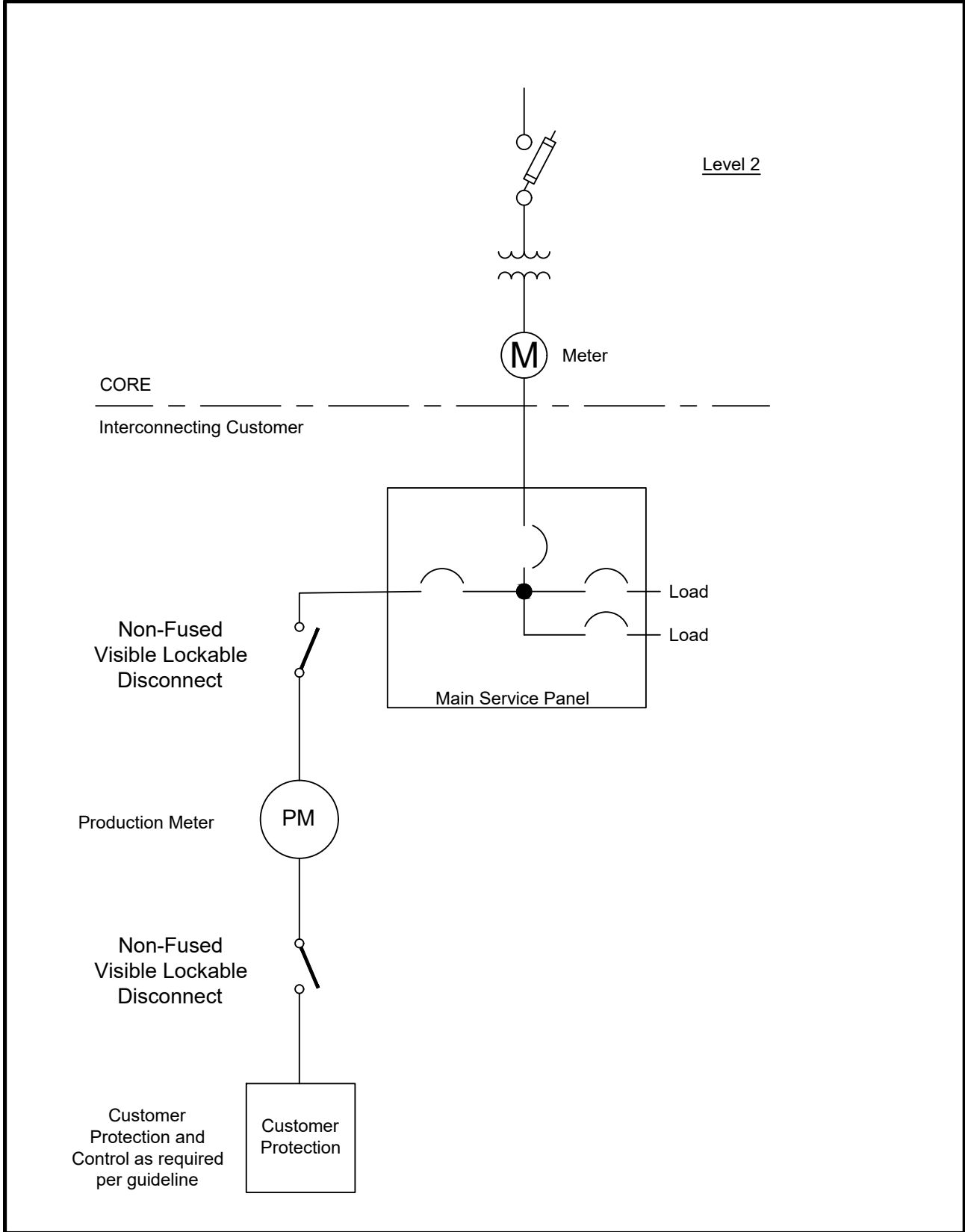

Example Level 2  
Production Meter (Required)  
One Line Diagram

APRIL 2024



DRAWN BY

ATS

APPROVED BY

|  |  |
|--|--|
|  |  |
|--|--|

|  |                            |                                       |            |
|--|----------------------------|---------------------------------------|------------|
|  | <b>Operating Procedure</b> | Procedure No.                         | 750-02     |
|  |                            | Revision No.                          | 6.2        |
|  |                            | Effective Date                        | 01/15/2025 |
| <b>Small Generating Interconnection Guidelines</b>                               |                            | <b>Distribution Restriction: None</b> |            |

## Appendix C - Signage

CORE requires the following signage to be installed on disconnects, meter housings (or PED) and or transformers. The signage shall be bright yellow background, made from plastic laminate, mounted with permanent adhesive or rivets on the disconnect switch cover or immediately adjacent to the disconnect in a location clearly visible. Signage shall be 2" x 4 $\frac{3}{4}$ " in size with 36 point Arial Bold font. The placard shall match the size and lettering illustrated as close as practical.

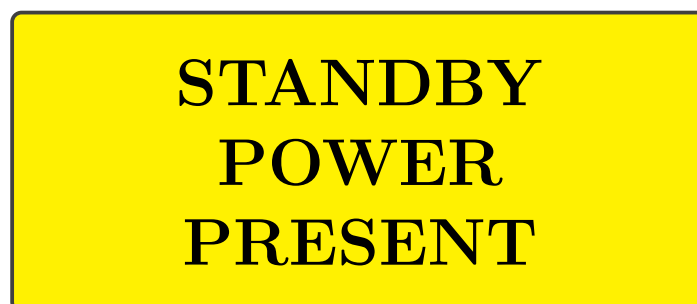
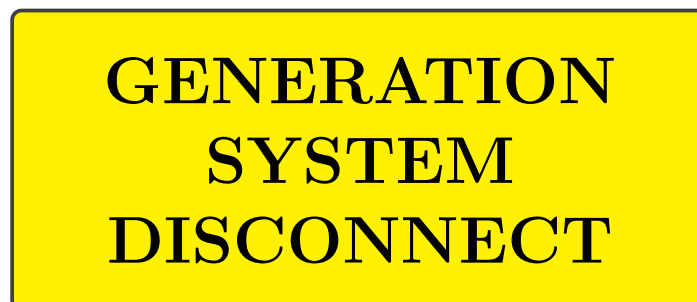
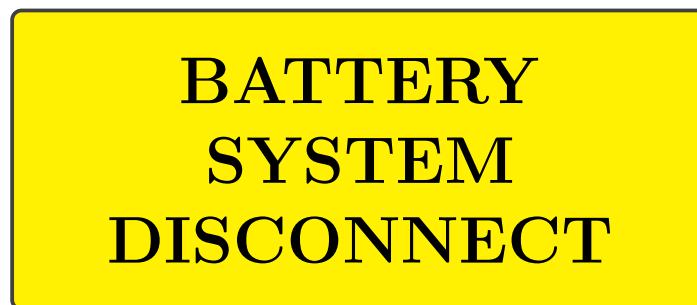

|  |                            |                                       |            |
|--|----------------------------|---------------------------------------|------------|
|  | <b>Operating Procedure</b> | Procedure No.                         | 750-02     |
|  |                            | Revision No.                          | 6.2        |
|  |                            | Effective Date                        | 01/15/2025 |
| <b>Small Generating Interconnection Guidelines</b>                               |                            | <b>Distribution Restriction: None</b> |            |

## Definitions

- Approve (Approval -or- Approved): *Acceptance*
- CORE: *Refers to CORE Electric Cooperative*
- ATO: *Automatic Throw Over*
- ATS: *Automatic Transfer Switch*
- Back-feed: *When power is induced back into the system.*
- Cable Runs: *Lengths of electric cable.*
- Capacitors: *Electrical Device that stores energy.*
- CBEMA: *“Computer Business Equipment Manufacturers Association”*
- Circuit Breakers: *Electrical Device that disconnects the circuit.*
- Consumers: *Any member fed from CORE’s System.*
- De-energized Circuits: *Circuit that is not powered; has been disconnected from the power source.*
- Delta formation: *Formation of both the source and load. Connected in a ‘Δ’ shape.*
- DER (Distributed Energy Resource): *Physical and virtual assets that are deployed across the distribution grid, typically close to load, and usually behind the meter which can be used individually or in aggregate to provide value to the grid, individual customers, or both.*
- Distribution: *A system with voltages smaller than 44kV*
- Effective Grounding: *Method of creating the best grounding system for a given system that will create a safe operating system.*
- Eligible Energy Resources: *Any renewable resource (i.e. sunlight, solar, hydro) that has been harvested for the conversion to electricity.*
- Facilities: *a place, amenity, or piece of equipment provided for a particular purpose*
- FERC: *Federal Energy Regulatory Commission*
- Frequency: *The number of oscillations in a power wave per period of time.*
- Generation: *The production of electrical energy.*
- Grounded Conductors: *A created system hazard, fault that occurs when a conductor is given a direct path to ground.*

|  |                            |                                       |            |
|--|----------------------------|---------------------------------------|------------|
|  | <b>Operating Procedure</b> | Procedure No.                         | 750-02     |
|  |                            | Revision No.                          | 6.2        |
|  |                            | Effective Date                        | 01/15/2025 |
| <b>Small Generating Interconnection Guidelines</b>                               |                            | <b>Distribution Restriction: None</b> |            |

- Harmonics: *A component of frequency of an oscillating wave.*
- HLRB (Hot Line Reclose Blocking): *The process of tripping off, by a recloser, in one shot and 'blocking' or not allowing the recloser device to reclose back into islanded generation. \*\*Islanded generation is not allowed on CORE's system. Generation should completely isolate from the grid in the event that CORE trips off for any reason.\*\**
- Hot Transfer: *Switching between two energized systems, to minimize the disturbance.*
- IEEE: *"Institute of Electrical and Electronics Engineers"*
- Induction Generators: *An AC machine that produces electrical energy, using induction principals.*
- Interconnection Customer: *Any customer who connects their generation facility to CORE's system.*
- Inverter: *Electrical device that converts DC to AC*
- Islanding (Accidental Isolation): *(p.5) When a portion of CORE's load is isolated from CORE's system, while still being connected to an Interconnection Customers Facility.*
- kV (Kilo-Volt): *Unit of Voltage*
- kW(kilo-Watt): *Unit of Active Power*
- Lagging: *When Phasor Current Lags Phasor Voltage, negative PF.*
- Large Generating Facilities: *Facilities that produce more than twenty (20)MW.*
- Leading: *When Phasor Current Leads Phasor Voltage, positive PF.*
- Magnitude:
- Maintain (Maintenance): *Provide with necessities for existence and normal operation.*
- NEC: *National Electrical Code*
- NERC: *North American Electric Reliability Corporation*
- Negative Sequence: *When the system has a rotating sequence ACB, the rotation of generation moves in a clockwise manor.*
- Network: *A connection of systems.*
- Neutral: *The neutral point of a system. Related to the grounding point of a system.*

|  |                            |                                       |            |
|--|----------------------------|---------------------------------------|------------|
|  | <b>Operating Procedure</b> | Procedure No.                         | 750-02     |
|  |                            | Revision No.                          | 6.2        |
|  |                            | Effective Date                        | 01/15/2025 |
| <b>Small Generating Interconnection Guidelines</b>                               |                            | <b>Distribution Restriction: None</b> |            |

- One-Line: *A diagram comprised of single lines and symbols that shows the route of the electric circuits and all devices used therein.*
- Out-of-Sync Reclosing: *The hazardous act of reclosing a system, while it is out of phase.*
- PCC (Point of Common Coupling): *The metering point between CORE's system and the consumers system.*
- PF (Power Factor): *Ratio of Active power to Apparent Power*
- Positive Sequence: *When the system has a rotating sequence ABC, the rotation of generation moves in a counterclockwise manor.*
- Production Meter: *A meter installed by CORE to measure output of all renewable energy production.*
- Protective Devices: *Devices used to protect Electrical Systems.*
- PSO (Parallel Systems Operation): *Any system operating in parallel to CORE's System.*
- PV (Photo-Voltaic): *The production of electrical energy from electromagnetic radiation of visible light from the sun.*
- Reclosing: *The action of reclosers disconnecting lines.*
- Reclosers: *Device that disconnects sections of lines*
- Relay: *Logic Elements of Protection Systems*
- SGIA (Small Generation Interconnection Agreement):
- SGIG (Small Generation Interconnection Guidelines): *Guidelines presented within these pages.*
- SGIP (Small Generation Interconnection Procedure): *Procedures for interconnection in the document 750-01.*
- Short Circuit: *The relationship between the current in the short-circuited armature winding and the field current.*
- Small Generating Facilities: *(p.5) Any Generating Facility, Qualifying Facility, device, system, or distributed resource which produces electricity with total nameplate generating capacity connected at one meter location less than twenty (20)MW that plans to interconnect with CORE's system under the Level 1 Process, Level 2 Process or Level 3 Process under the SGIP.*
- Small Power Interconnection Customers:
- Step-up Transformer: *A transformer that steps up voltage; from low to high.*



|  |                            |                                       |            |
|--|----------------------------|---------------------------------------|------------|
|  | <b>Operating Procedure</b> | Procedure No.                         | 750-02     |
|  |                            | Revision No.                          | 6.2        |
|  |                            | Effective Date                        | 01/15/2025 |
| <b>Small Generating Interconnection Guidelines</b>                               |                            | <b>Distribution Restriction: None</b> |            |

- Synch-Check Supervision: *See Hot Line Reclose Blocking.*
- System: *Electric Distribution System*
- THD (Total Harmonic Distortion): *The measurement of harmonic distortion.*
- Thevenin Equivalent Impedance: *A calculated, single, equivalent impedance of a system.*
- Transformer: *An electrical device that converts electrical energy from high to low, or low to high via inductance.*
- Transmission: *A system with voltages larger than 69kV*
- Tripping: *The act of protection device being alerted of possible system faults.*
- Utility Disconnect Switch: *Switch required by CORE, which will disconnect any consumer from the system.*
- VAR: *Unit of Reactive Power*
- Voltage Flicker: *The quick fluctuation of voltage.*
- Voltage: *the force of an electrical current; units: Volts.*
- Wye formation: *Formation of both the source and load. Connected in a ‘Y’ shape. Contains a Neutral wire.*
- Zero Sequence: *A sequence where there is no angle addition, phasors add to zero. Used for testing and troubleshooting.*